

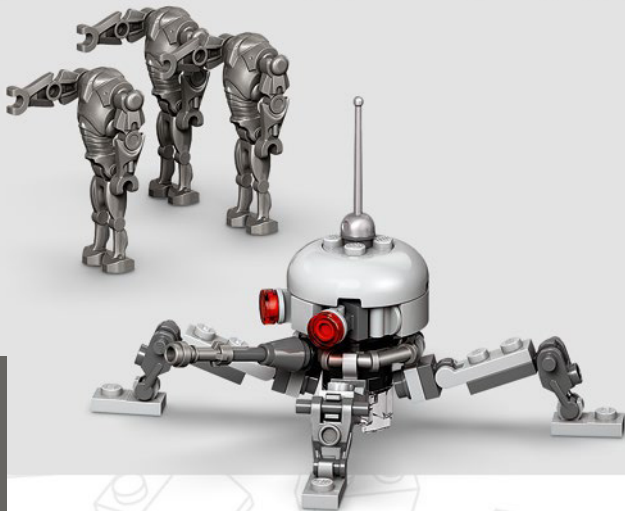

# STAR WARS™

75431



Q LEGO® Builder

1



### **Get excited about our new packaging!**

We're switching from plastic to paper-based packaging. That's why you might find a mix of paper and plastic in our boxes!

### **Nos nouveaux emballages vous emballeront !**

Nous passons des emballages en plastique aux emballages à base de papier. C'est pourquoi vous pourriez trouver un mélange de papier et de plastique dans nos boîtes !

### **¡Te presentamos nuestros nuevos empaques!**

Estamos sustituyendo las bolsas de plástico por bolsas con base de papel. ¡Por eso, puedes encontrar una mezcla de papel y de plástico en nuestras cajas!

**[LEGO.com/sustainable-packaging](https://www.lego.com/sustainable-packaging)**



Q LEGO® Builder

# BUILDER



Apple and the Apple logo are trademarks of Apple Inc., registered in the U.S. and other countries and regions. App Store is a service mark of Apple Inc. Google Play and the Google Play logo are trademarks of Google LLC. Tencent and the Tencent logo are trademarks of Tencent Inc.

Q [LEGO.com/devicecheck](https://www.lego.com/devicecheck)

**EN** Ask parents' permission before going online | **DE** Eltern um Erlaubnis bitten, bevor du online gehst | **FR** Demande l'autorisation d'un parent avant d'aller en ligne | **IT** Chiedi il permesso ai tuoi genitori prima di andare online | **ES** Pídeles permiso a tus papás antes de conectarte a Internet | **PT** Pede autorização aos pais antes de acederes online | **ZH** 上网前应先征得父母的同意 | **PL** Poproś rodziców o zgodę, zanim wejdiesz do Internetu | **CS** Než půjdeš na internet, požádej rodiče o svolení | **SK** Skôr než pôjdeš na internet, vypýtaj si povolenie od rodičov | **HU** Kérj szülői engedélyt, mielőtt online csatlakoznál! | **UA** Запитуйте дозволу батьків, перш ніж користуватися інтернетом | **RO** Cere permisiunea părinților înainte de a te conecta online | **BG** Поискайте разрешение от родител, преди да влезете онлайн | **LV** Pirms došanās tiešsaistē palūdz atļauju vecākiem | **ET** Enne Interneti kasutamist küsi vanematelt luba | **LT** Prieš prisijungdami prie interneto, atsiklauskite tėvų





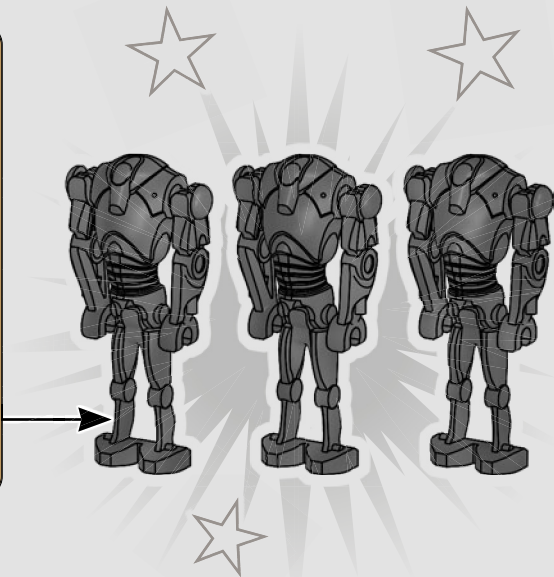
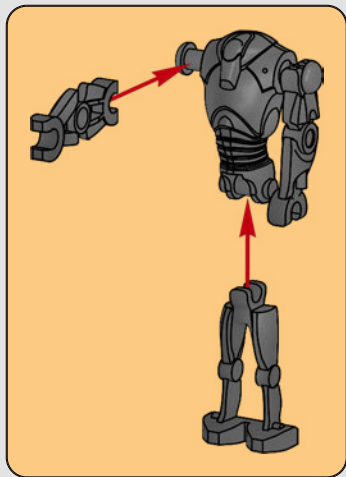



1x

1





2x

2





1x

3

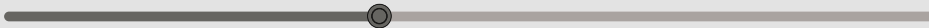
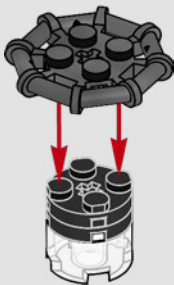



1x

4

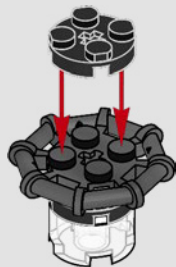



4x

5

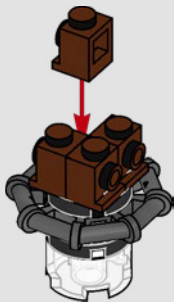



1x

6

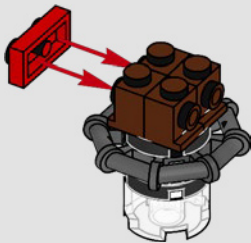



2x



2x

7

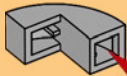

2x



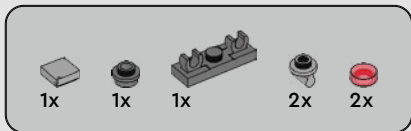

8

1

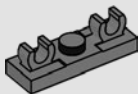

2

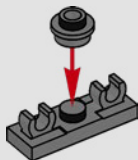

3

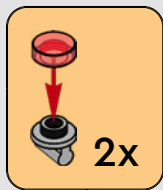
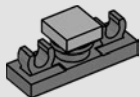

4

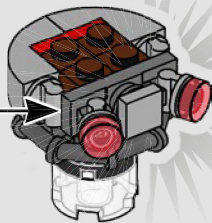
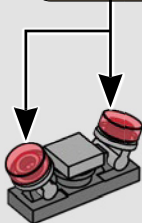

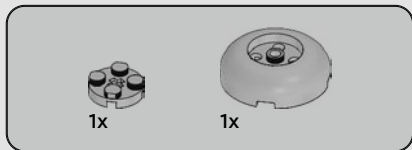

9

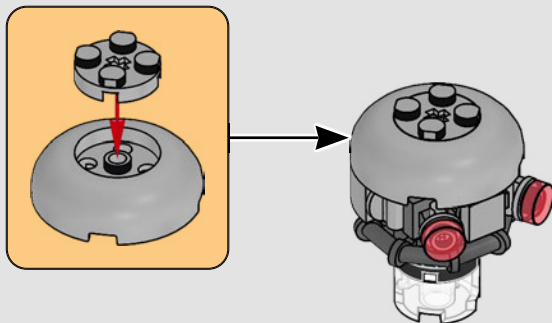



1x



1x



1x



1x

# 10

1

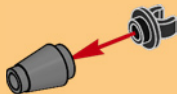

2

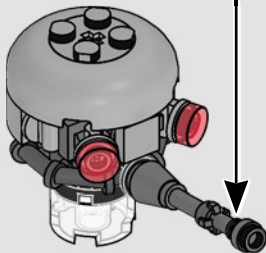
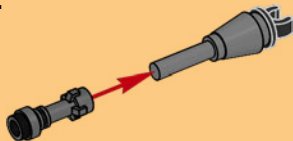

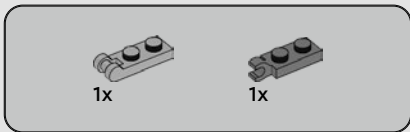
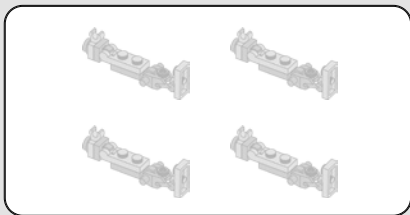

11

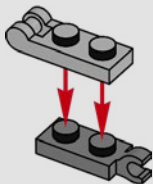



1x



1x



1x

# 12

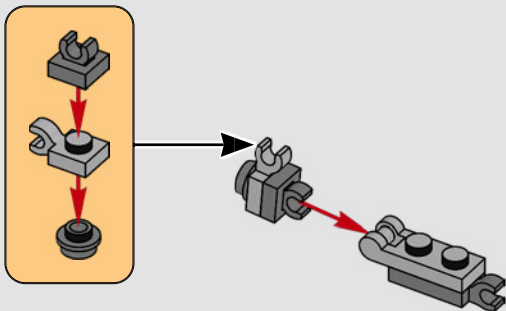

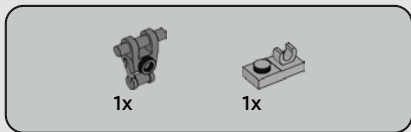

13

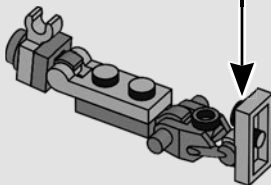
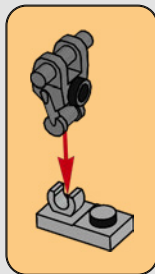

4x

14

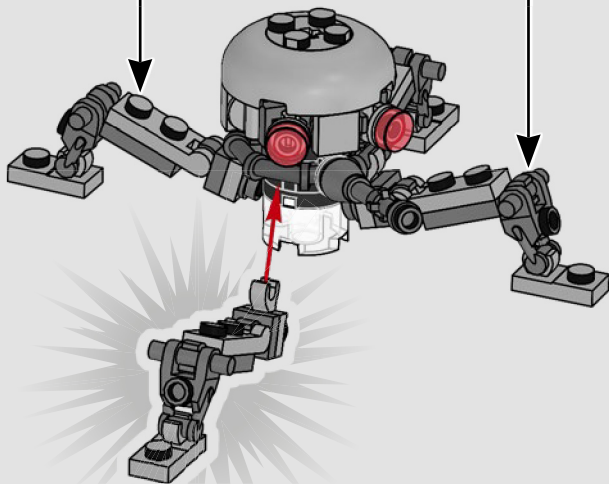

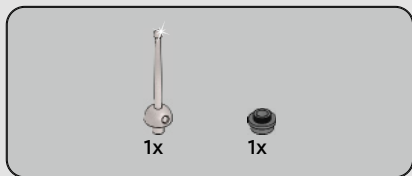

15



16

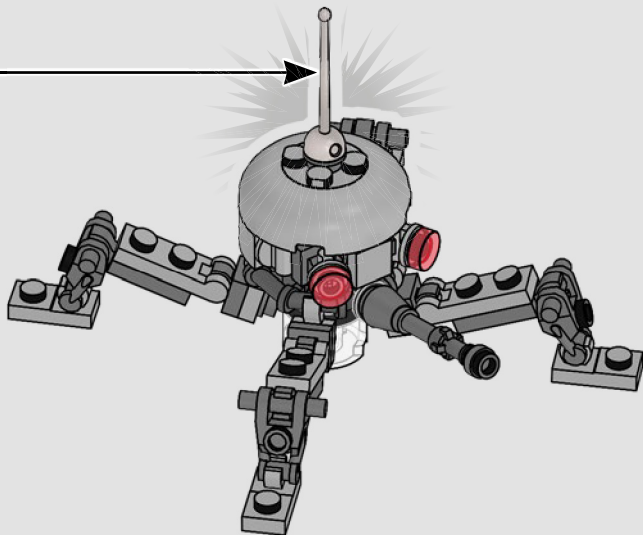

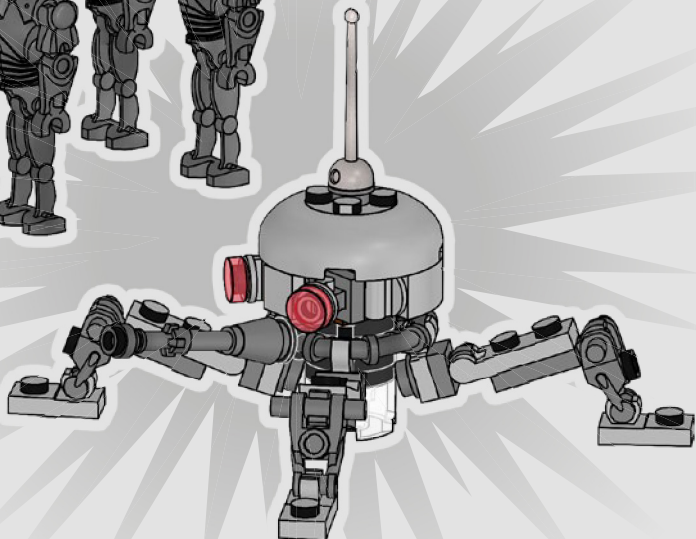
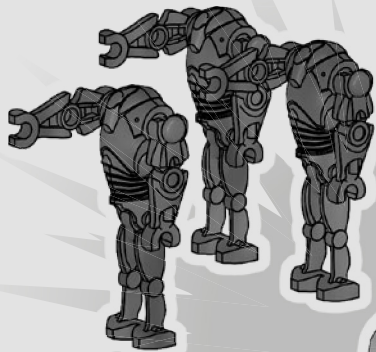



# STAR WARS™

75431



2



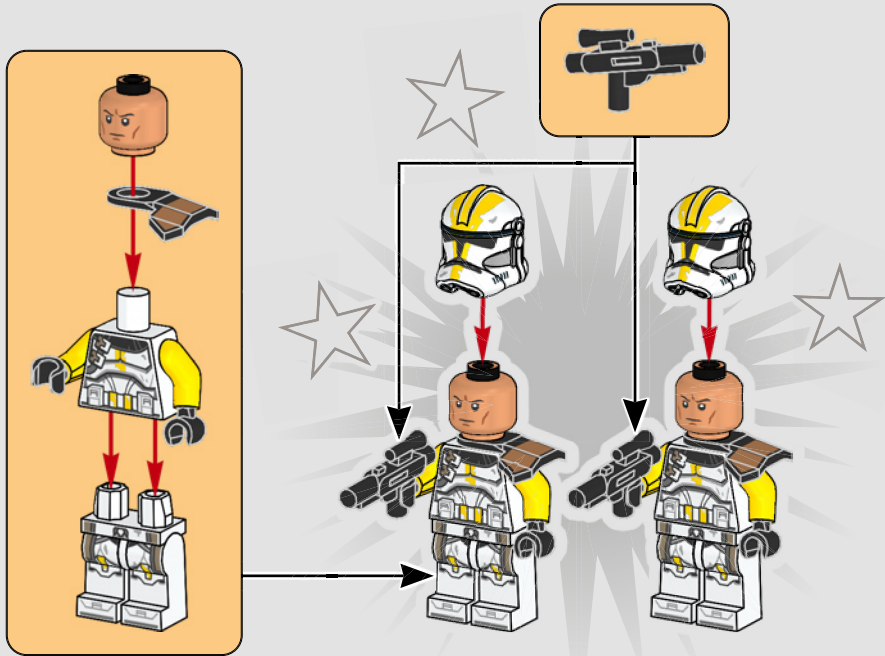



1x

1



4





1x

2

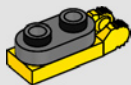

1x

3

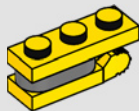



1x

4

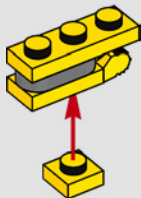

6





1x

5

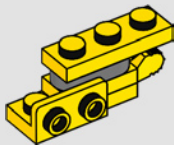

1x

6

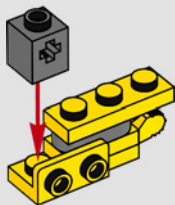



1x

7

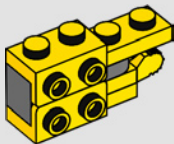

8





1x

8

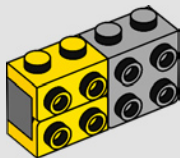

1x



1x



1x



1x

9

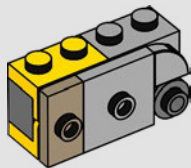



1x



1x

# 10

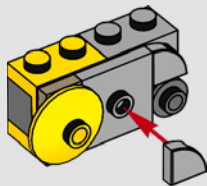

10



1x

# 11

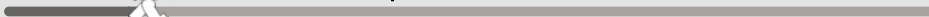
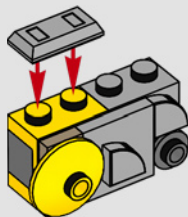

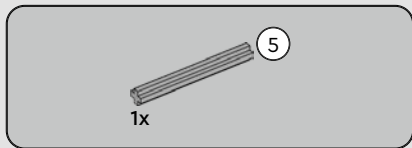

12

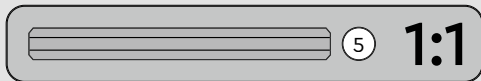
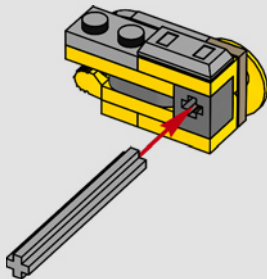



1x

# 13

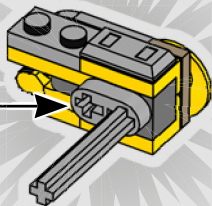

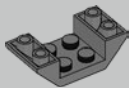
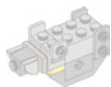

1x

14

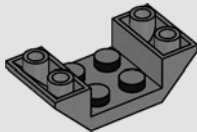



2x

# 15

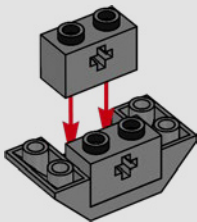

14





2x

16

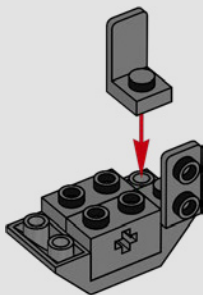

1x

17

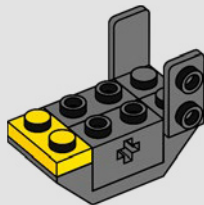



1x

# 18

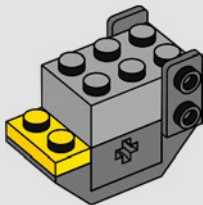

16



2x

19

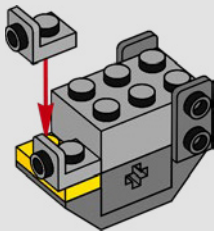

1x

20

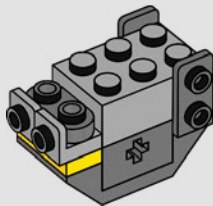



2x

# 21

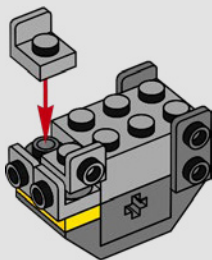



1x



1x



2x

# 22

1

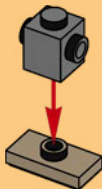

2

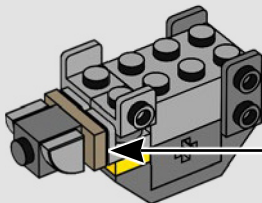
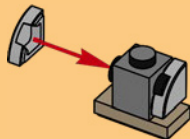

23

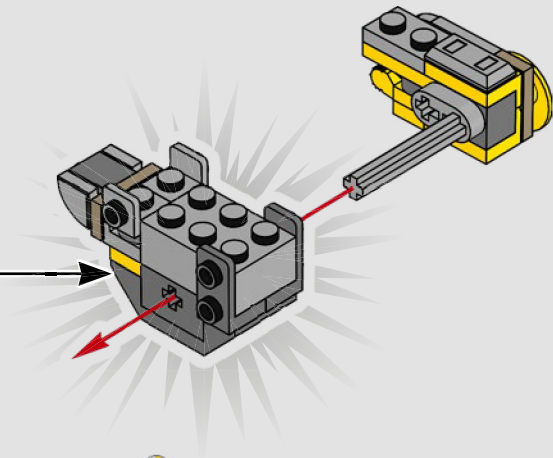



1x

24

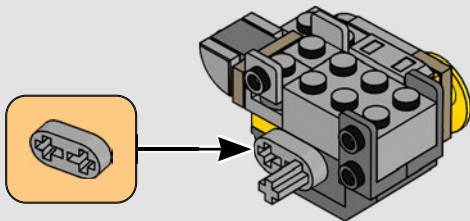



1x

# 25





1x

26

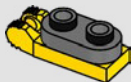

1x

27





1x

# 28

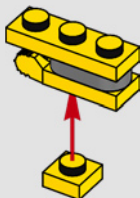

24





1x

29

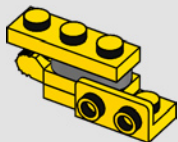

1x

30

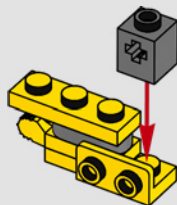



1x

31

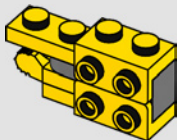



1x

32

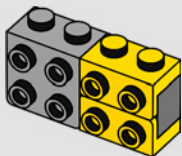

1x



1x



1x



1x

33

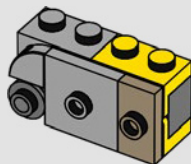



1x



1x

# 34

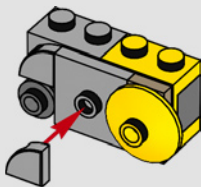

1x

# 35

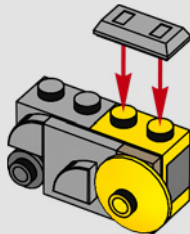

36

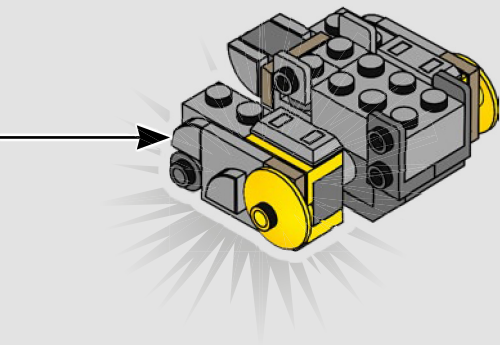

37

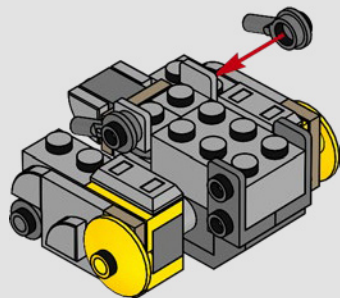

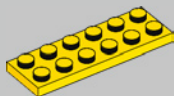

1x

# 38

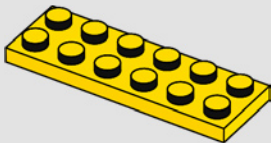

30



2x

39

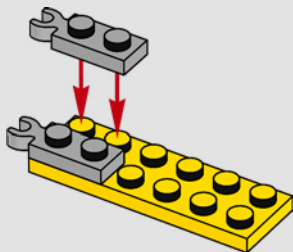

1x

40

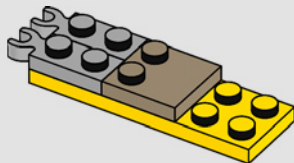



2x

41

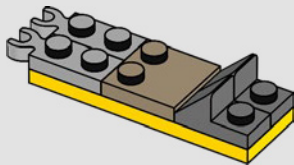



2x

42

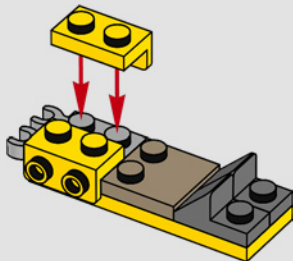

1x

43

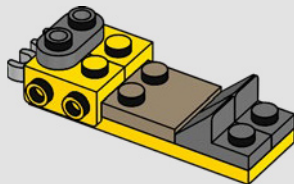



1x

44

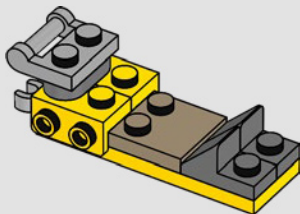



2x

45

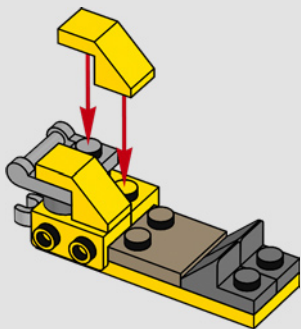

2x



2x

46

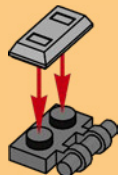
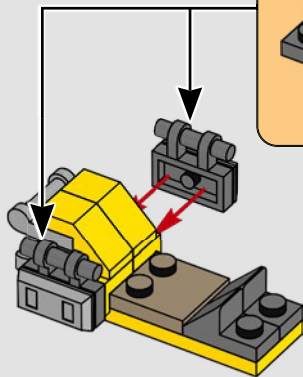

2x

47

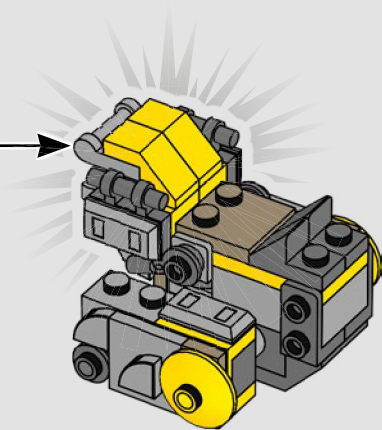



1x

48

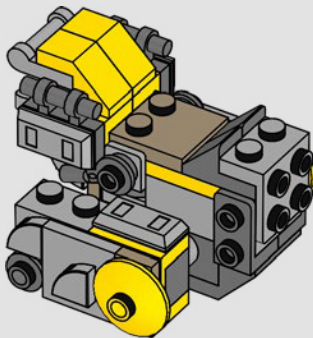



1x

49

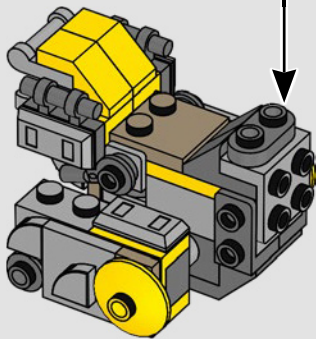

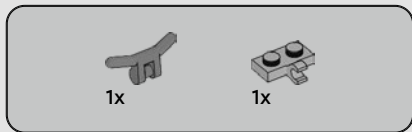

50

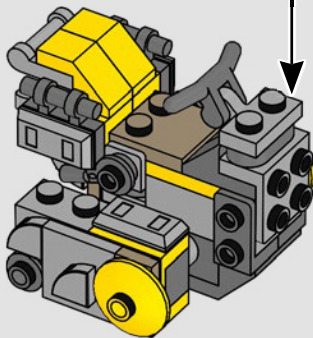
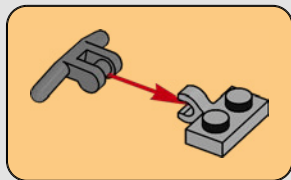



2x

# 51

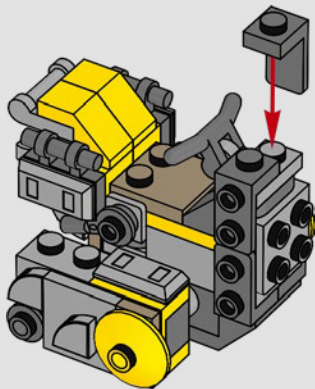





1x



1x

# 54

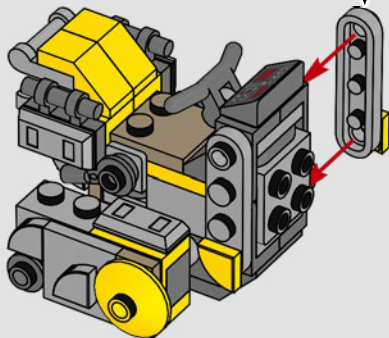
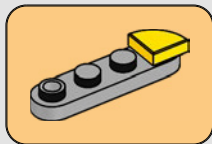



1x



1x

55

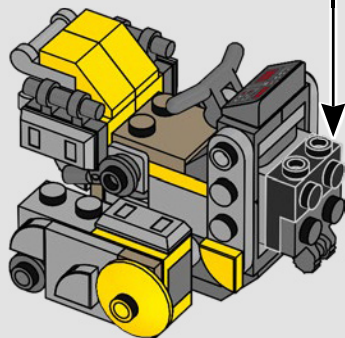
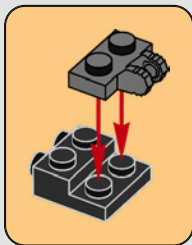



1x



1x

# 56

1

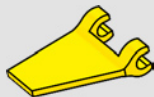

2



3

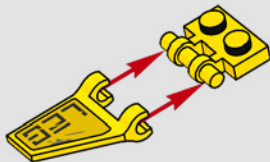

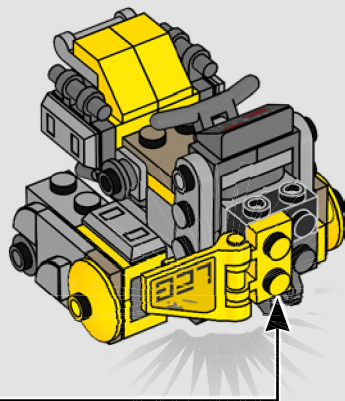



1x



1x

# 57

1

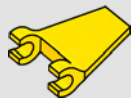

2



3

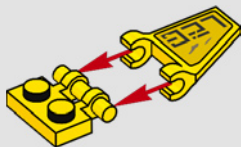

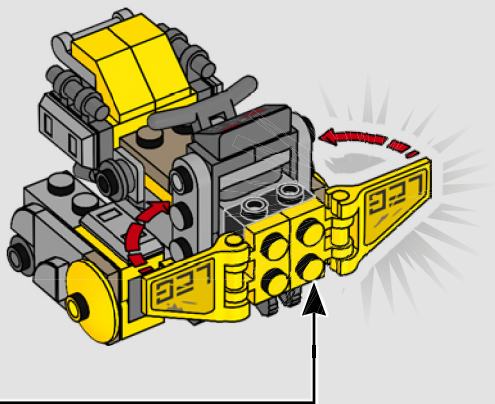



1x



1x

# 58

1

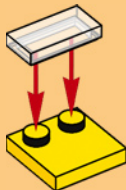

2

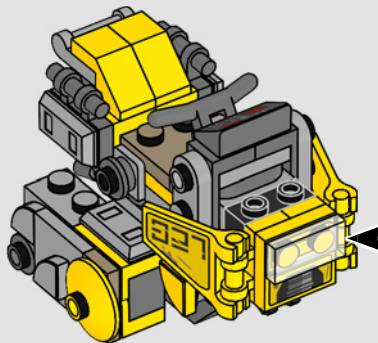



1x

59

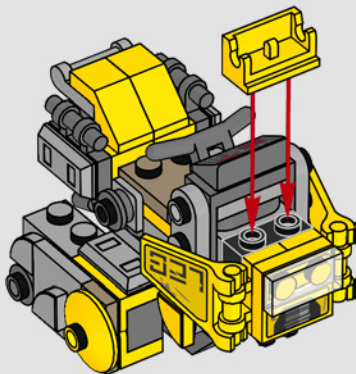

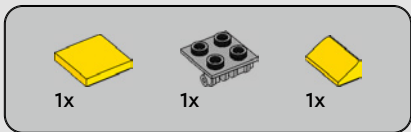

60

1



2



3

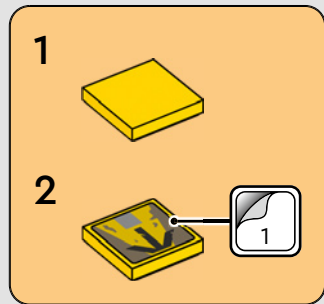
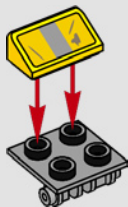

4



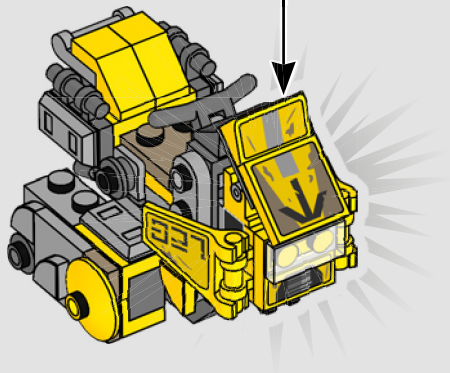



1x



1x

# 61

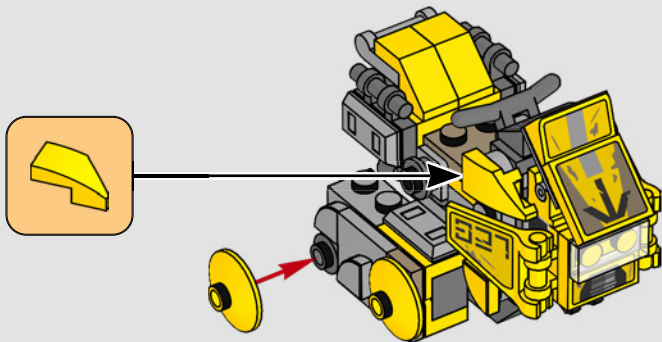



1x



1x

# 62

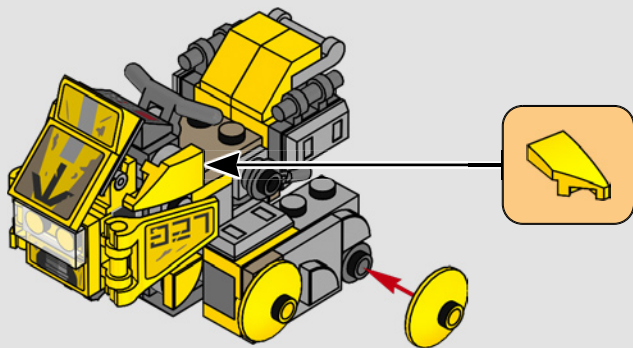



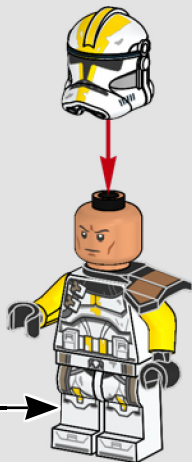
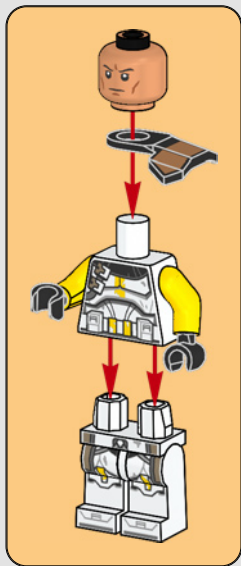

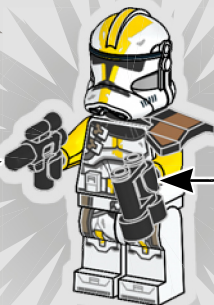

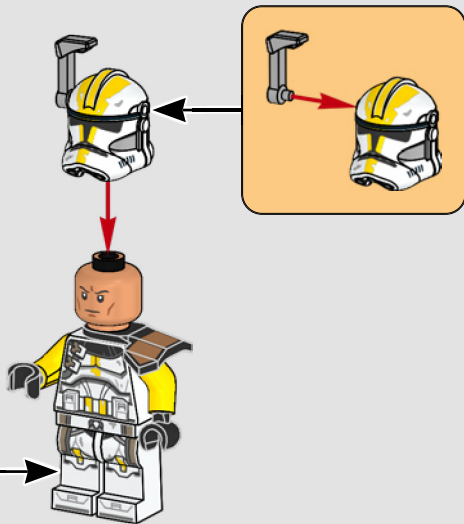
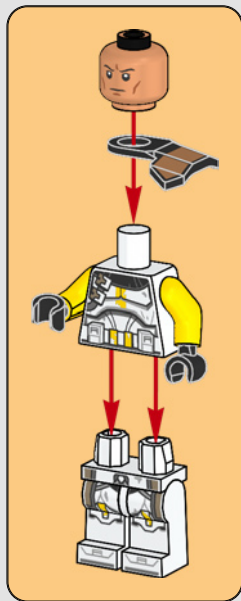

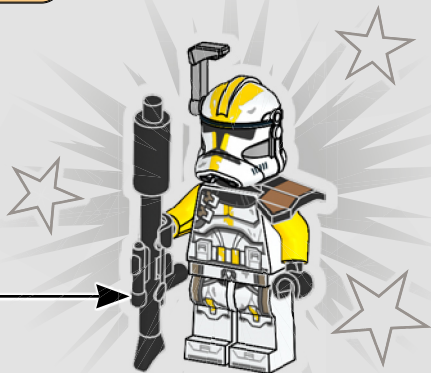
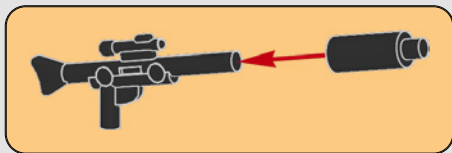



1x

63





1x

64

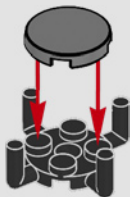

1x

65

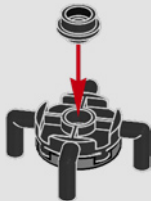



1x



1x

66

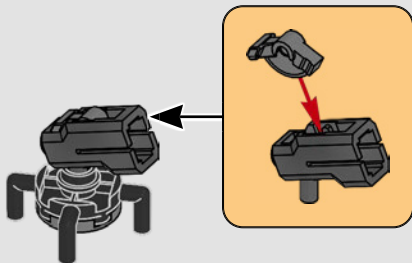

3x

67

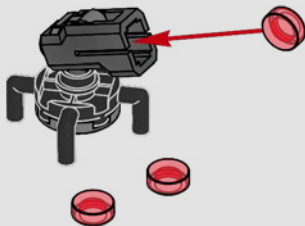

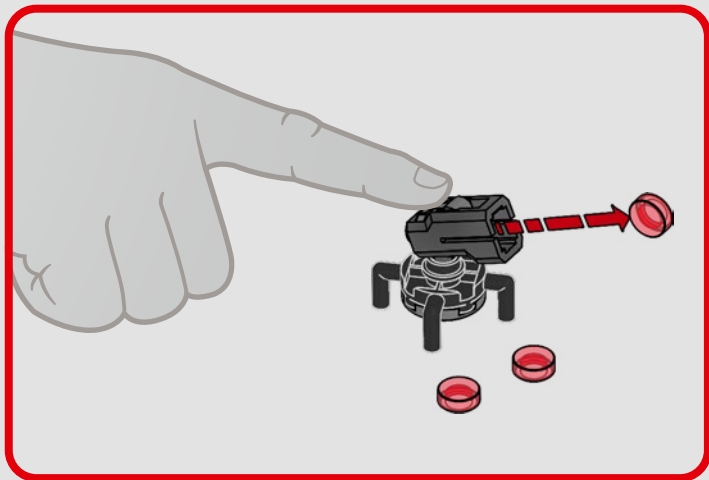

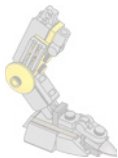

1x

68





1x

69



1x

70

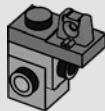



1x

71

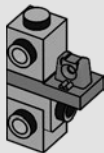



1x

# 72

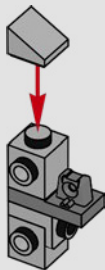

1x

# 73

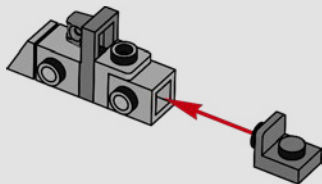
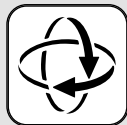

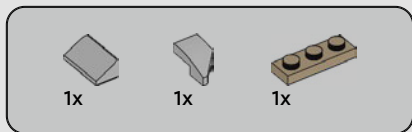

74

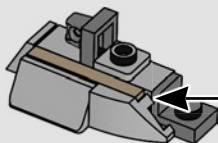
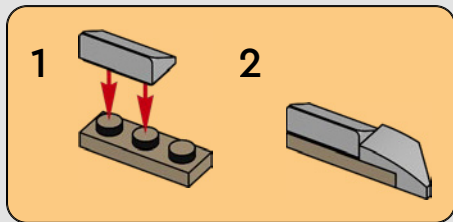

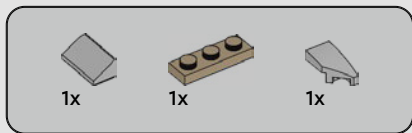

75

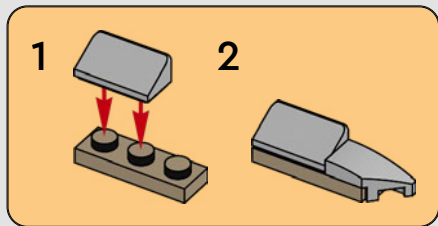



1x



1x



1x

# 76

1

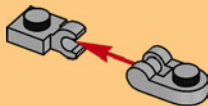

2

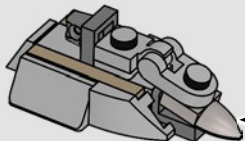
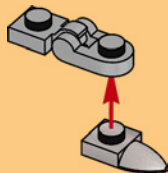

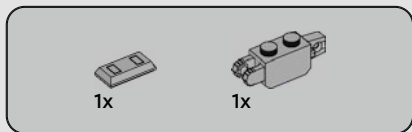

77

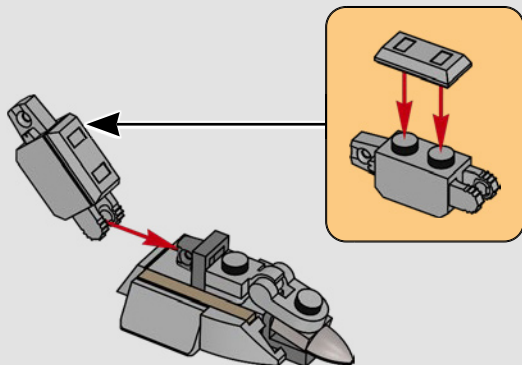

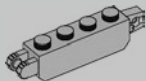

1x

# 78

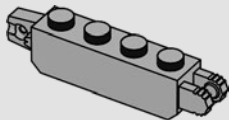



1x



1x

# 79

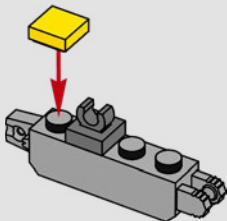



1x

80

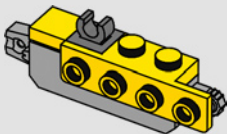



1x



1x

# 81

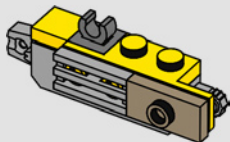

1x

# 82

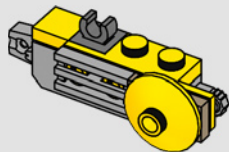



1x

83

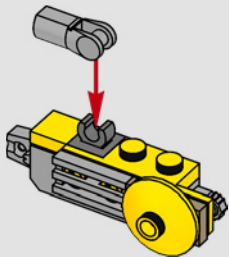

84

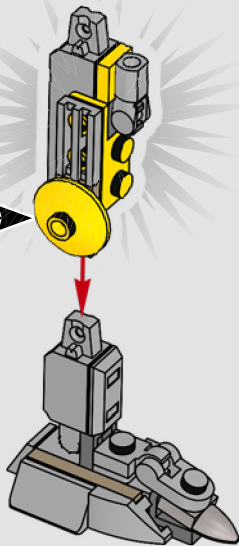

85

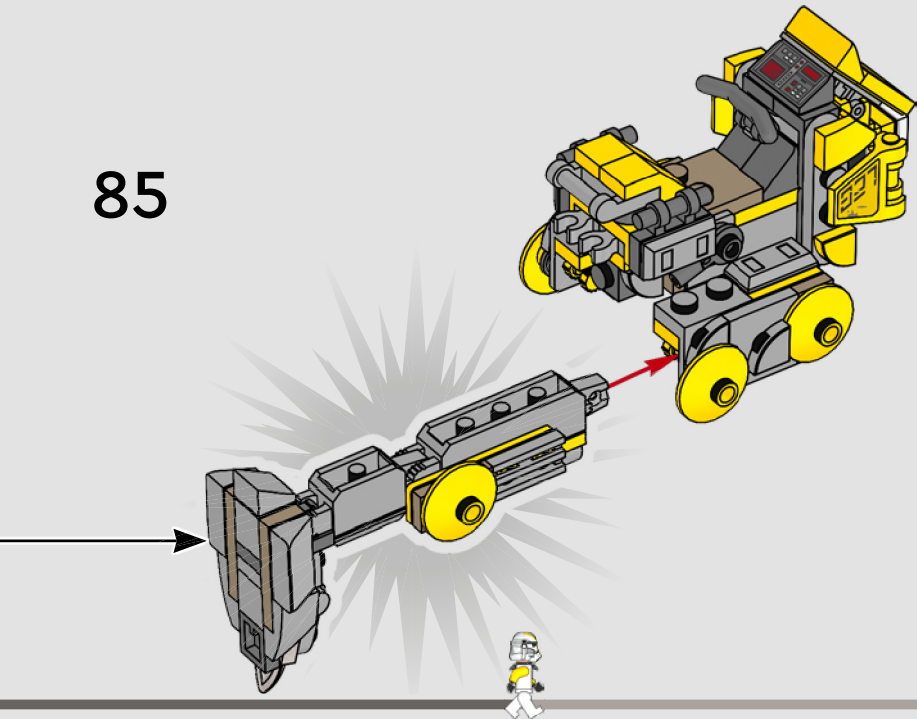

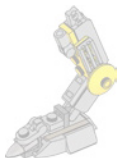

1x

86





1x

87



1x

88

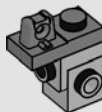



1x

89

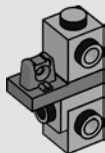



1x

90

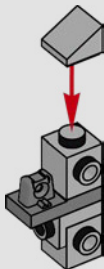

1x

91

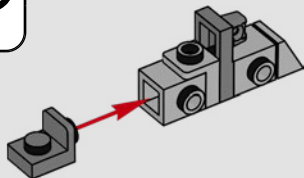



1x



1x



1x

# 92

1

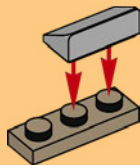

2

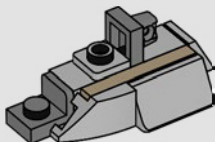
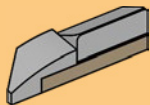

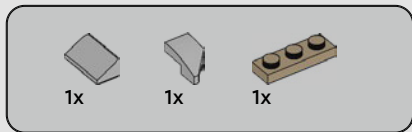

93

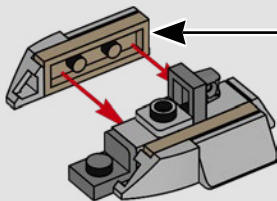
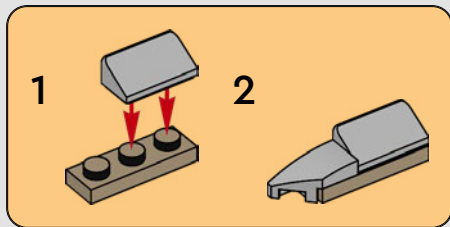



1x



1x



1x

# 94

1

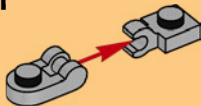

2

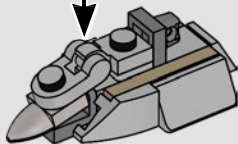
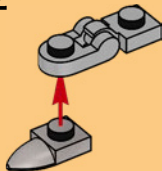

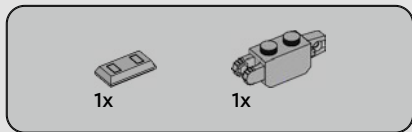

95

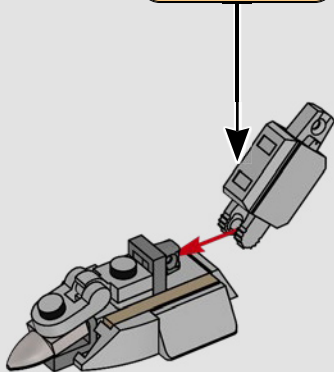
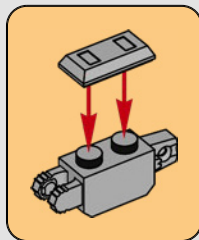

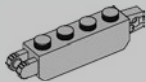

1x

96

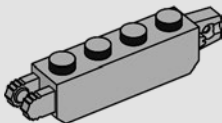



1x



1x

# 97

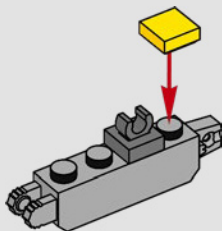



1x

98

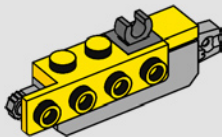



1x



1x

99

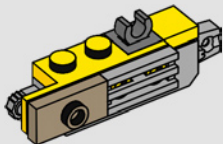

1x

100

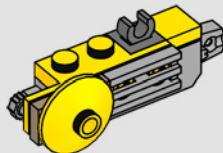



1x

# 101

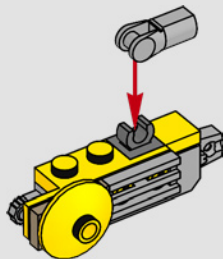

102

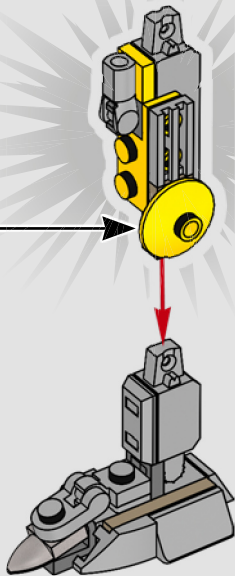

103

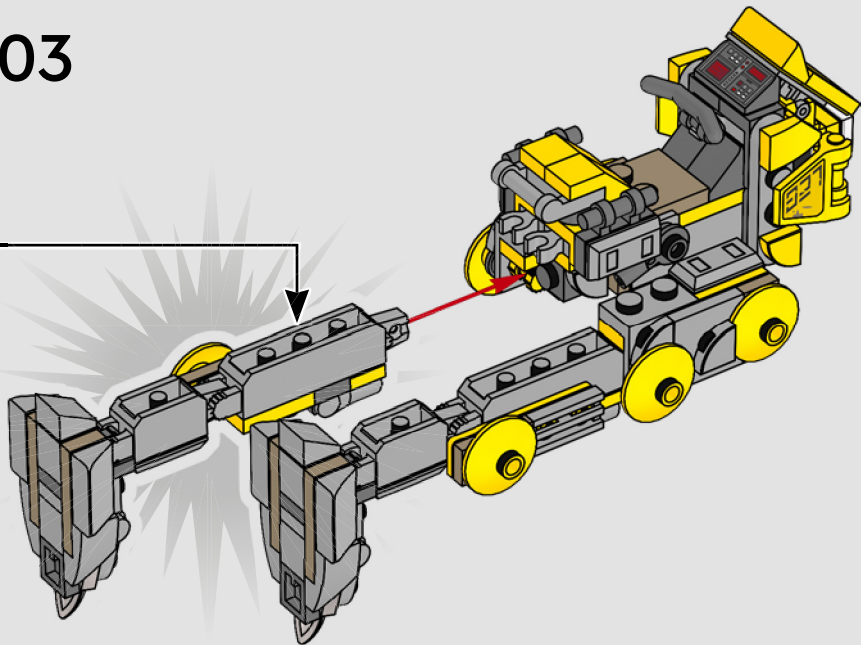

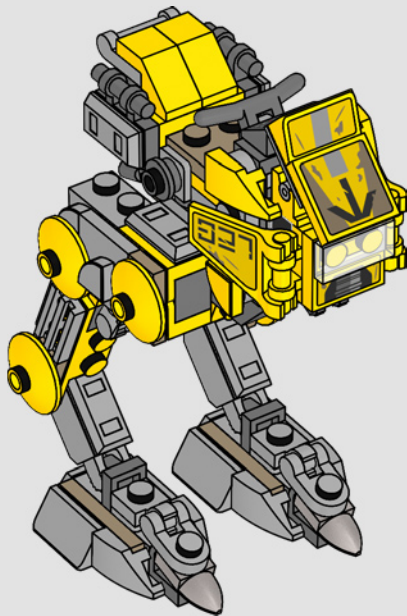

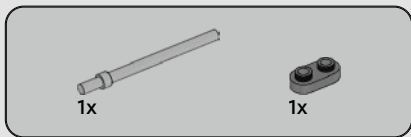

# 104

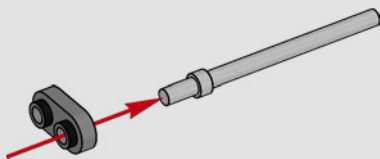



1x

# 105

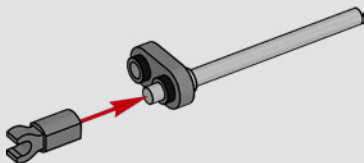



1x

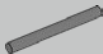

1x

# 106

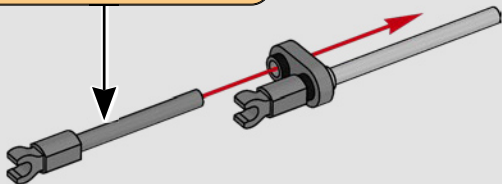
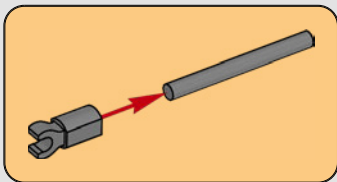

107

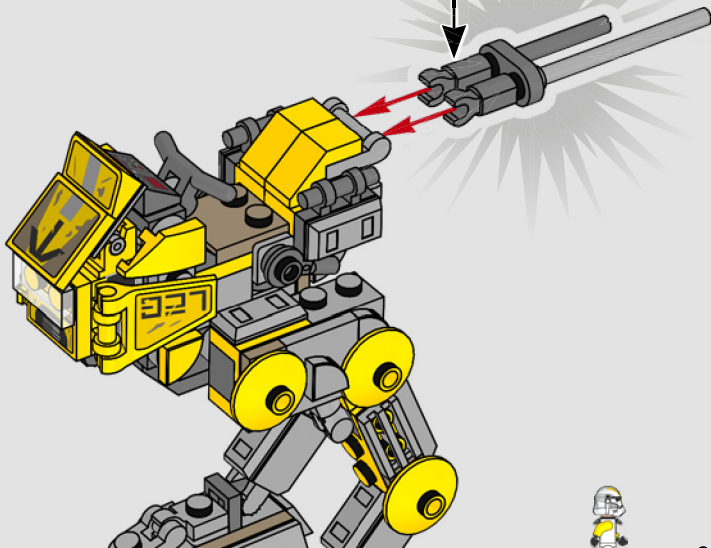

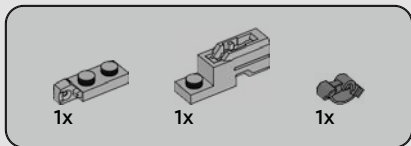

# 108

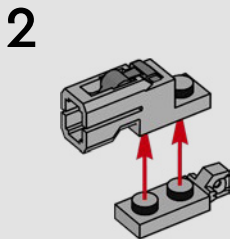
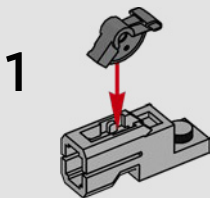

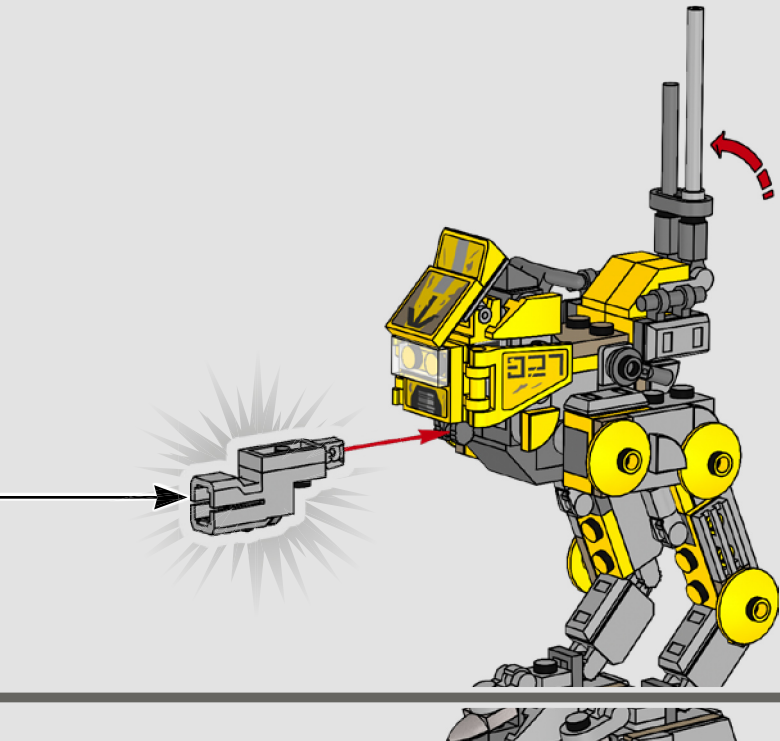



1x



109

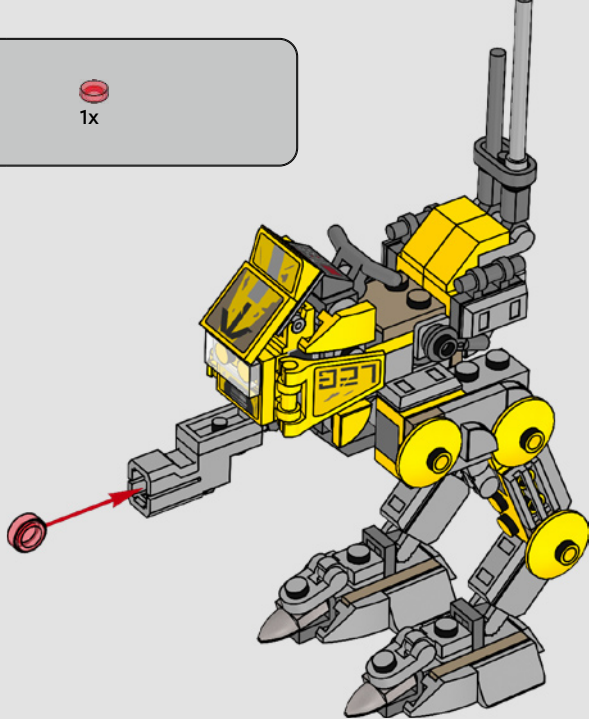

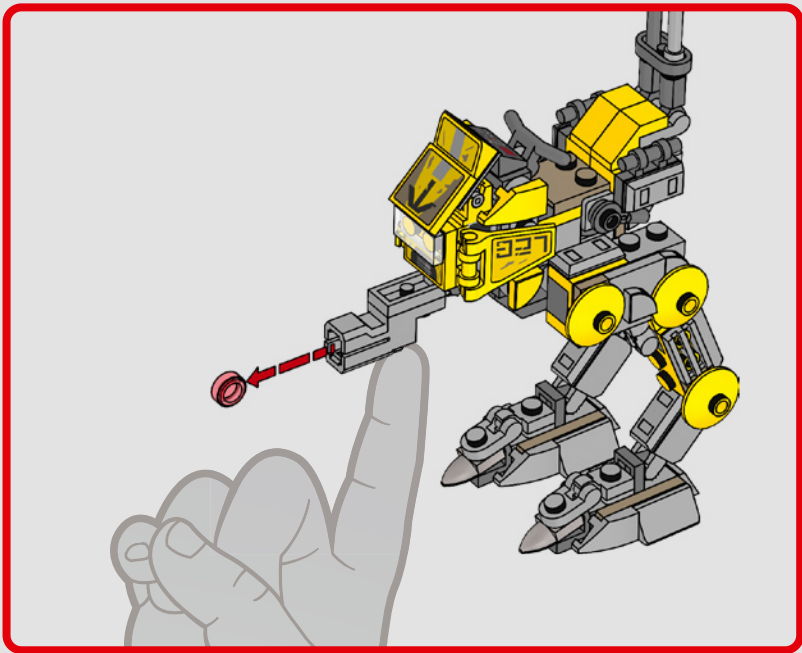

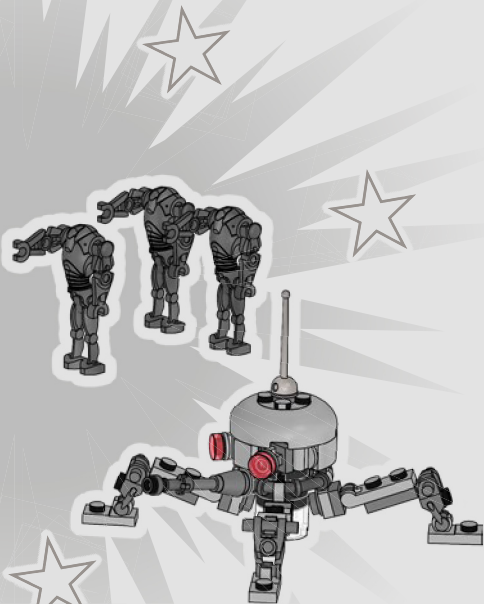
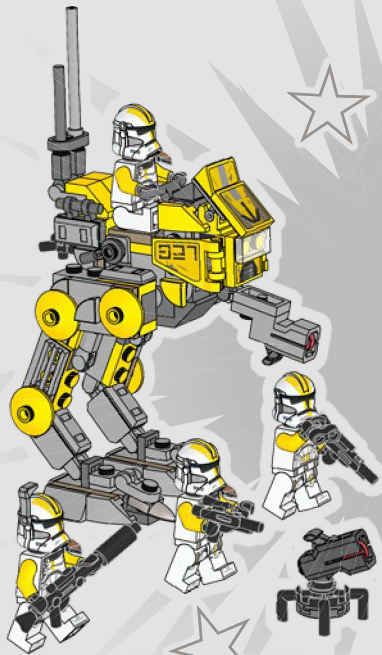



4x  
6549363



4x  
6549365



4x  
6567615



4x  
6308125



1x  
302321



2x  
6195183



1x  
6289740



2x  
302424



2x  
307024



1x  
6289743



1x  
4550348



6x  
4169960



2x  
6228597



1x  
302324



1x  
393724



4x  
6185994



2x  
6057458



2x  
6449912



2x  
4140587



1x  
6224666



1x  
306824



2x  
6267046



2x  
362324



2x  
6168616



1x  
379524



1x  
6290456



1x  
6534180



1x  
6168646



1x  
6360207



1x  
6003301



3x  
403226



4x  
6565209



2x  
4498713



1x  
6469445



1x  
6313508



1x  
4498712



1x  
6514281



1x  
6514223



6x  
6514189



5x  
6092591



1x  
6396392



4x  
6132768



4x  
4225469



1x  
6528128



2x  
6343976



4x  
6510218



6x  
6176433



2x  
4521921



2x  
6225139



1x  
4211415



4x  
6335328



2x  
6248078



4x  
4213567



6x  
6335378



2x  
6348143



2x  
6225246



2x  
6225142



4x  
4568637



1x  
4211475



6x  
6134378



1x  
6313114



2x  
4211350



2x  
6548933



4x  
6326078



3x  
6117967



1x  
4244627



2x  
6354568



1x  
6266231



2x  
6126082



1x  
4211881



2x  
6569496



1x  
6360382



4x  
4515369



2x  
6456718



1x  
4211386



1x  
6503232



1x  
4211639



2x  
6314473



1x  
6170418



2x  
6336970



1x  
4529240



2x  
6362259



6x  
6344022



2x  
6336390



2x  
6435043



2x  
6225494



1x  
4213574

5



8x  
6231765



2x  
6360675



6x  
6221607



2x  
6388118



4x  
4521512



1x  
6152814



1x  
6056296



1x  
6342558



2x  
6178919



2x  
6069164



2x  
6265693



1x  
4261908



2x  
4210660



4x  
6336990



1x  
6310596



1x  
6365692



1x  
6378143



1x  
4211076



1x  
6222063



2x  
4625146



6x  
6470260



3x  
6568510



3x  
6467932



1x  
6122727



1x  
6345880



1x  
6197967

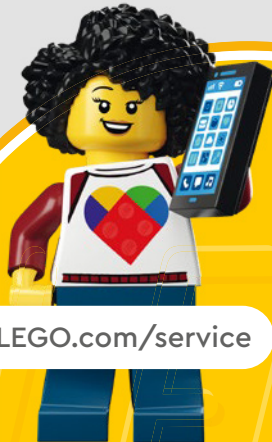

[LEGO.com/service](https://www.LEGO.com/service)



# STAR WARS

75435





YOU COULD **WIN**



Scan this QR code or go to **LEGO.COM/PRODUCTFEEDBACK** and give us your short feedback about this LEGO® set for a chance to win a cool LEGO prize.

Terms and Conditions apply\*

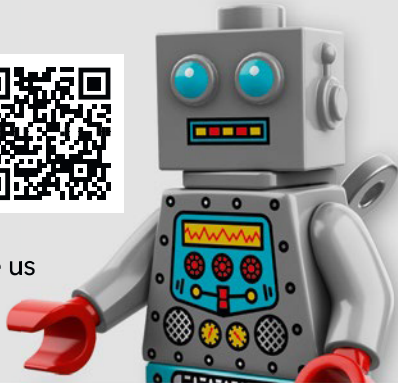

**EN: YOU COULD WIN.** Terms and Conditions apply\* **DE: Du könntest GEWINNEN.** Es gelten die Teilnahmebedingungen\* **FR: Tu pourrais GAGNER.** Des conditions s'appliquent\* **IT: Potresti VINCERE tu.** Termini e condizioni sono applicabili\* **ES: Puedes GANAR.** Aplican términos y condiciones\* **PT: PODERÁ GANHAR.** Aplicam-se Termos e Condições\* **ZH: 轻松获奖.** 条款和条件适用\* **PL: Szansa na WYGRANĄ.** Obowiązuje regulamin\* **CS: Máte šanci VYHRÁT.** Platí všeobecné smluvní podmínky\* **SK: Máte šancu VYHRÁŤ.** Platia všeobecné zmluvné podmienky\* **HU: TE IS NYERHETSZ.** Felhasználási feltételek érvényesek\* **UA: ВИ МОЖЕТЕ ВИГРАТИ.** Застосовуються загальні положення та умови\* **RO: Ai putea CÂȘTIGA.** Se aplică termeni și condiții\* **BG: Можете да СПЕЧЕЛИТЕ.** Има определени правила и условия\* **LV: Tu vari LAIMĒT.** Ir spēkā noteikumi un nosacījumi.\* **ET: Sul on võimalus VÕITA.** Kehtivad tingimused\* **LT: Jūs galite LAIMĖTI.** Taikomos sąlygos\*

\*[LEGO.com/productfeedback-terms](https://www.lego.com/productfeedback-terms)

LEGO and the LEGO logo are trademarks of the/son des marques de commerce du/son marcas registradas de LEGO Group. ©2025 The LEGO Group.

© & ™ Lucasfilm Ltd.



6595780